



FOLDERS/BINDERS *to support your image*

NPN360°



CONTENTS

- 3 NON-REINFORCED POCKET FOLDERS
- 4 REINFORCED FOLDERS
BOX POCKET FOLDERS
- 5 3 PANEL FOLDERS
- 6 FAST FOLDERS
BUSINESS CARD SLITS
DISK SLITS
WINDOWS
- 7 REPORT COVERS
- 9 CD SLEEVES
CD MAILERS
VIDEO PACKAGING
- 11 BINDERS
TANG PRODUCTS
- 12 CONFORMER® PRODUCTS
- 13 PORTFOLIOS
TOTES
BOXES
- 14 CUSTOM PACKAGING
- 15 COMMERCIAL PRINTING
- 16 FOIL STAMPING
EMBOSSING
DIE CUTTING



FABCO
ARDAR
Ardel

TEXTRON Fastening
Commercial Solutions



Hickory Valley
RESIDENT CENTER

Chattanooga's
Finest
Retirement
Community

WELCOME

QS/1.

NON-REINFORCED POCKET FOLDERS

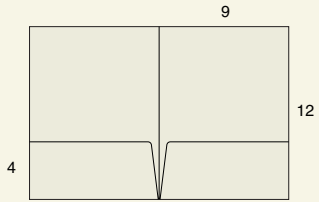

M-100 9 x 12 Folder with (2) 4" glued pockets

M-101 9 x 12 Folder with (2) 3" glued pockets (not pictured)



M-102 9 x 12 Folder with (1) 4" right glued pocket

M-103 9 x 12 Folder with (1) 3" right glued pocket (not pictured)

M-104 9 x 12 Folder with (1) 4" left glued pocket (not pictured)

M-105 9 x 12 Folder with (1) 3" left glued pocket (not pictured)

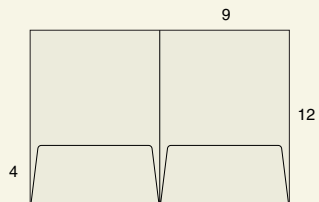

M-106 9 x 12 Folder with (2) 4" unglued flaps

M-107 9 x 12 Folder with (1) 4" unglued right flap (not pictured)

M-108 9 x 12 Folder with (1) 4" unglued left flap (not pictured)

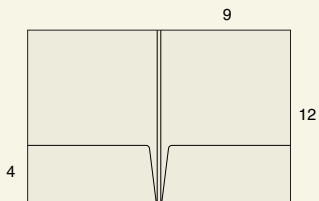

M-109 9 x 12 Folder with (2) 4" glued pockets and 1/4" spine

M-110 9 x 12 Folder with (2) 4" glued pockets and 1/2" spine (not pictured)

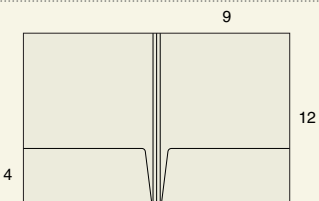

M-111 9 x 12 Folder with (2) 4" glued pockets and triple score spine

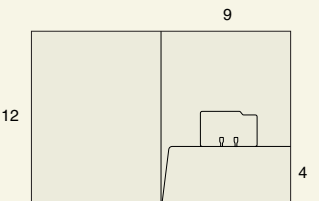

M-112 9 x 12 Folder with (1) 4" glued pocket and file card

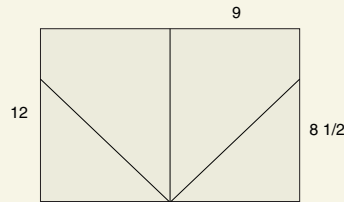

M-113 9 x 12 Folder with (2) 8 1/2" glued angled pockets

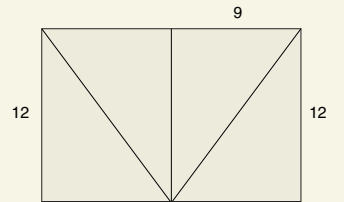

M-114 9 x 12 Folder with (2) 12" glued angled pockets



M-115 9 x 12 Folder with (1) 4" horizontal pocket and (1) 4" vertical pocket

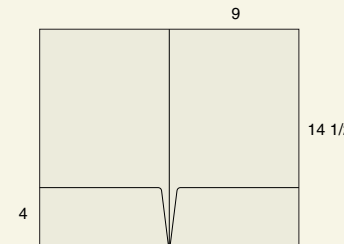

M-116 9 x 14 1/2 Legal size folder with (2) 4" glued pockets

M-117 9 x 14 1/2 Legal size folder with (2) 3" glued pockets (not pictured)

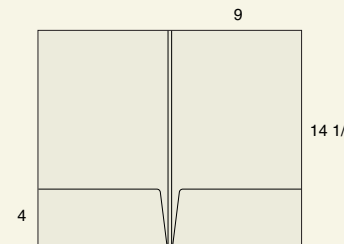

M-118 9 x 14 1/2 Legal size folder with (2) 4" glued pockets and 1/4" spine

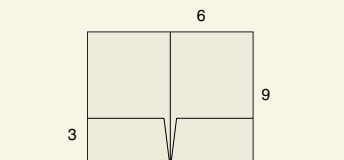

M-119 6 x 9 Mid size folder with (2) 3" glued pockets

M-120 6 x 9 Mid size folder with (1) 3" right glued pocket (not pictured)

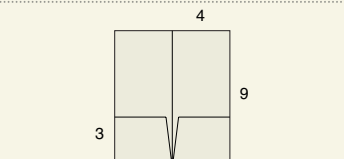

M-121 4 x 9 Mini folder with (2) 3" glued pockets

M-122 4 x 9 Mini folder with (1) 3" right glued pocket (not pictured)

Folders on this page are produced on 12 Pt. C/1/S stock except legal size folders that are on 14 Pt. C/1/S. Other stocks are available upon request.

See page 6 for optional center "Tang" attachments that are available for all 9 x 12 folders on this page. Also listed on page 6 are samples of our **Free** business card slits, CD and brochure slits and windows.

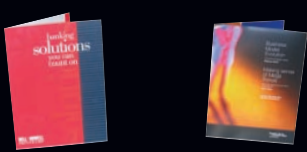

REINFORCED FOLDERS • BOX POCKET FOLDERS

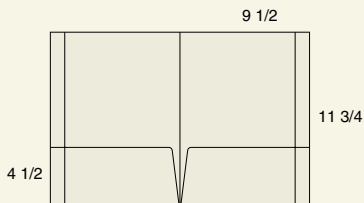

M-200 9 1/2 x 11 3/4 Folder with (2) 4 1/2" glued pockets

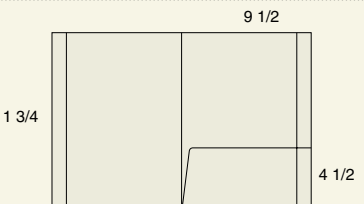

M-201 9 1/2 x 11 3/4 Folder with (1) 4 1/2" right glued pocket

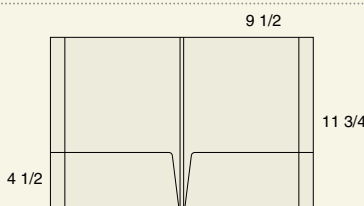

M-202 9 1/2 x 11 3/4 Folder with (1) 4 1/2" left glued pocket (not pictured)

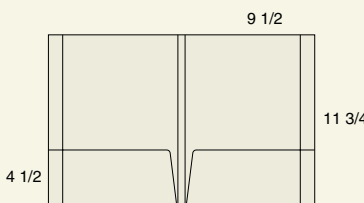

M-203 9 1/2 x 11 3/4 Folder with (2) 4 1/2" glued pockets and 1/4" spine

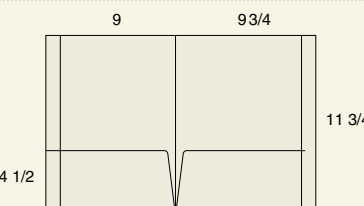

M-204 9 1/2 x 11 3/4 Folder with (2) 4 1/2" glued pockets and 1/2" spine

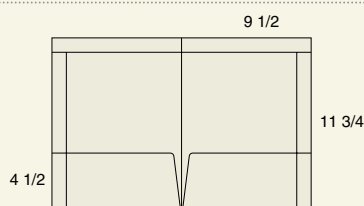

M-205 9 3/4 x 11 3/4 Folder with (2) 4 1/2" glued pockets and extended tab

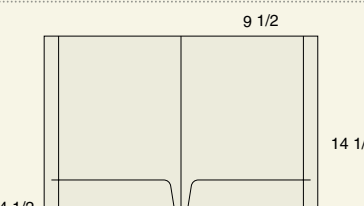

M-206 9 1/2 x 11 3/4 Folder with (2) 4 1/2" glued pockets and reinforced top

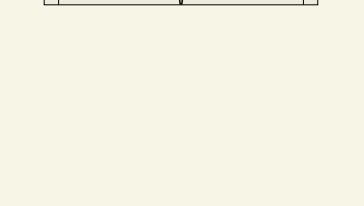

M-207 9 1/2 x 14 1/2 Folder with (2) 4 1/2" glued pockets

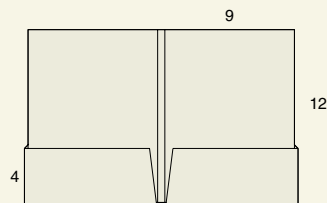

M-300 9 x 12 Folder with (2) 4" x 1/4" box pockets and 1/2" spine

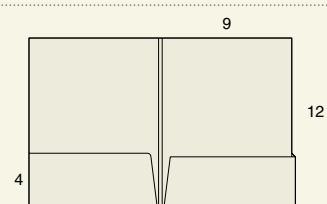

M-301 9 x 12 Folder with (1) 4" x 1/4" right box pocket and 1/4" spine (not pictured)

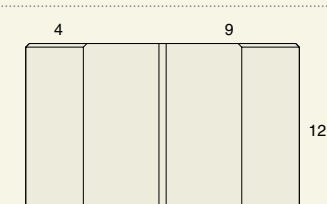

M-302 9 x 12 Folder with (1) 4" left flat glued pocket and (1) 4" x 1/4" right box pocket and 1/4" spine

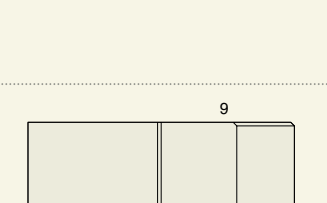

M-303 9 x 12 Folder with (2) vertical 4" x 1/4" box pockets and 1/2" spine

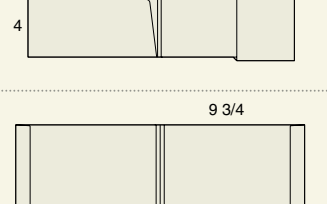

M-304 9 x 12 Folder with (1) vertical 4" x 1/4" right box pocket and 1/4" spine (not pictured)

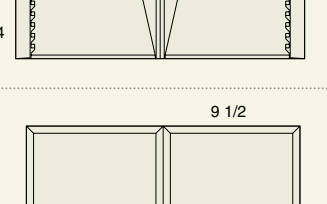

M-305 9 x 12 Folder with (1) 4" left flat glued pocket and (1) 4" x 1/4" right vertical box pocket and 1/4" spine

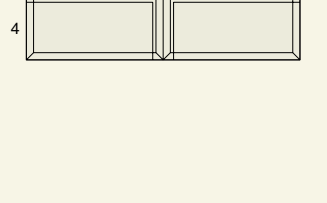

M-306 9 3/4 x 11 3/4 Folder with (2) 4 1/4" x 1/4" expandable zipper pockets and 1/2" triple score spine

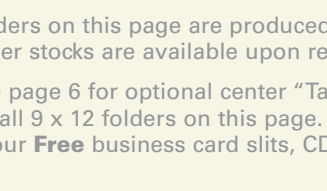

M-900 9 1/2 x 12 Conformer® Expansion Folder (see page 12)

Folders on this page are produced on 12 Pt. C/1/S stock. Other stocks are available upon request.

See page 6 for optional center "Tang" attachments that are available for all 9 x 12 folders on this page. Also listed on page 6 are samples of our **Free** business card slits, CD and brochure slits and windows.

3 PANEL FOLDERS

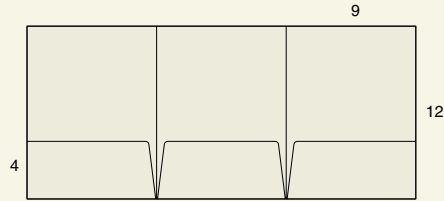

M-400 9 x 12 Folder with (2) 4" outside glued pockets and (1) 4" center unglued flap

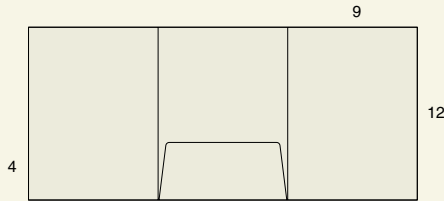

M-401 9 x 12 Folder with (1) 4" center unglued flap

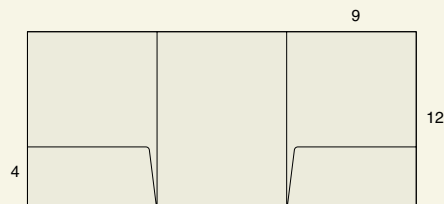

M-402 9 x 12 Folder with (2) 4" outside glued pockets

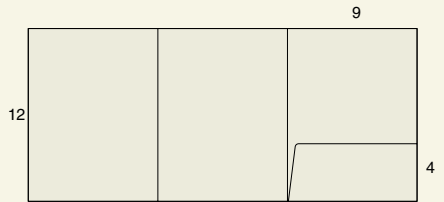

M-403 9 x 12 Folder with (1) 4" right glued pocket

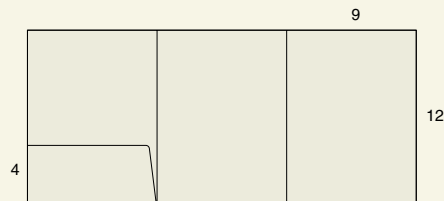

M-404 9 x 12 Folder with (1) 4" left glued pocket

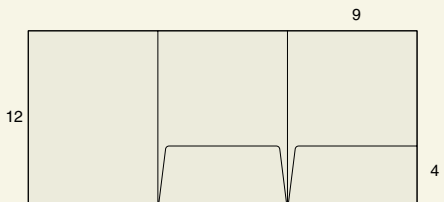

M-405 9 x 12 Folder with (1) 4" center unglued flap and (1) 4" right glued pocket

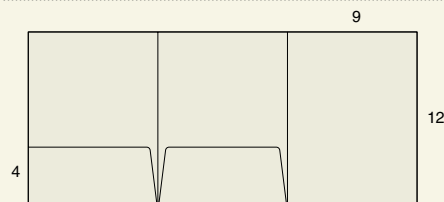

M-406 9 x 12 Folder with (1) 4" left glued pocket and (1) 4" center unglued flap

Folders on this page are produced on 12 Pt. C/1/S stock. Other stocks are available upon request.

See page 6 for samples of our **Free** business card slits, CD and brochure slits and windows.

FAST FOLDERS

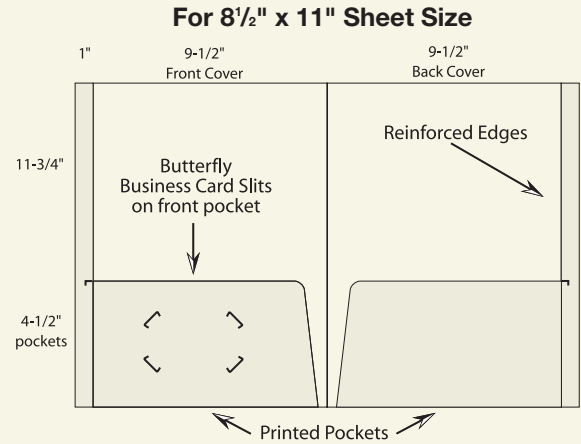

Fast Folders are in stock and ready for delivery. Produced on 12pt. laminated stock, Fast Folders can be silk screened, foil stamped or embossed. Order as few as 100 imprinted folders or 200 plain folders. Available in white, black, silver, red, blue or green.

BUSINESS CARD SLITS • DISK SLITS WINDOWS • TANG ATTACHMENTS

Business Card Slits

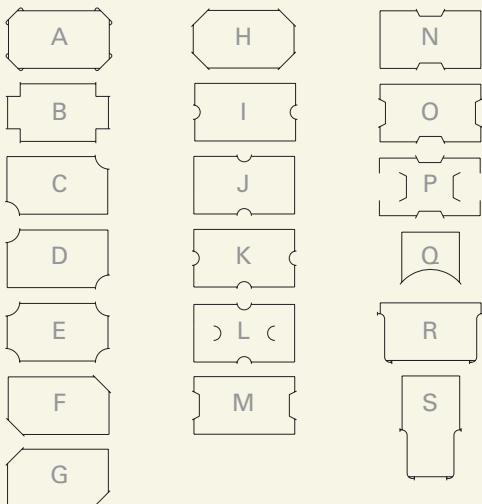

Disk & Brochure Slits

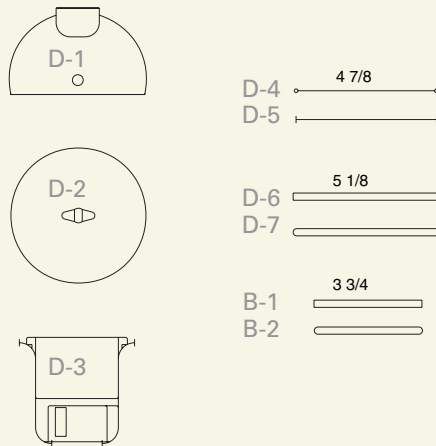

Windows



Tang Attachments

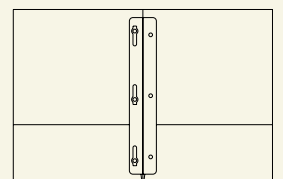

Tang attachments can be stitched into the center of most folders. They are 14 pt. C1S white stock and come standard with (3) 3/4" Tang fasteners and eyelets.



REPORT COVERS

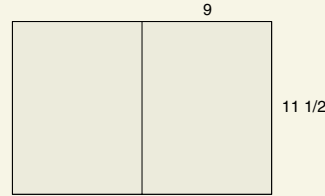
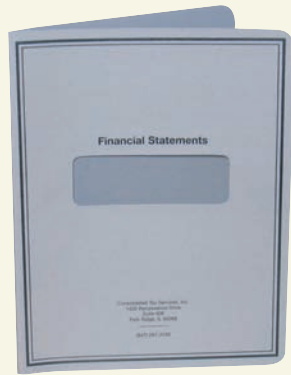

M-500 9 x 11 1/2 One piece report cover

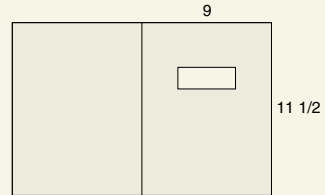

M-501 9 x 11 1/2 One piece report cover with window

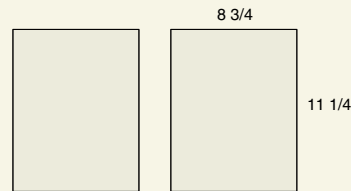

M-502 8 3/4 x 11 1/4 Two piece report cover

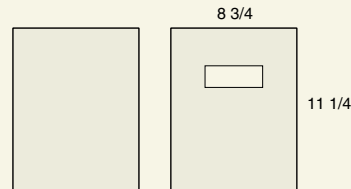

M-503 8 3/4 x 11 1/4 Two piece report cover with window



Round Corners

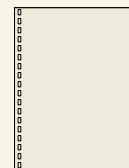

Comb Binding Punch

Base Papers

Carnival vellum cover - White, Water, Ice
 Synergy felt cover - White
 Synergy linen cover - White



White



Water

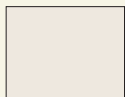

Ice

Group 1 Papers

Synergy felt cover - Prussian Blue, Black
 Synergy linen cover - Prussian Blue, Black



Mysterious Blue



Black

(Colors shown are approximate)

Report covers are a great way to dress up any report. See page 6 for window styles and optional center "Tang" attachments. Round corners and comb binding punching are also available.





CD SLEEVES • CD MAILERS VIDEO & CD PACKAGING



M-600 5 x 5
Single CD Sleeve

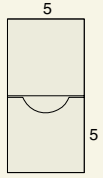

M-601 5 x 5
Single CD Sleeve with flap

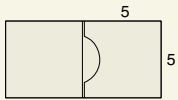

M-602 5 x 5
Single CD Sleeve with reinforced panel

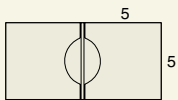

M-603 5 x 5
Double CD Sleeve

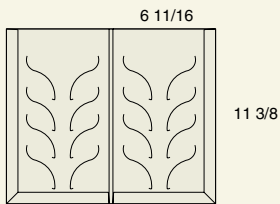

M-604 6 11/16" x 11 3/8"
CD Library
(holds 4,6 or 8 CD's)

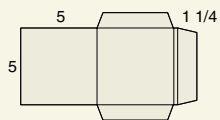

M-605 5 x 5 Economy
CD Mailer #1

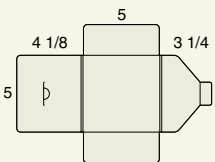

M-606 5 x 5 Economy
CD Mailer #2
Tuck closure



M-607 5 x 5
Single CD Mailer
with reinforced panel
Tuck closure

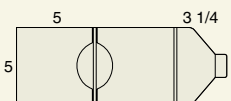

M-608 5 x 5
Double CD Mailer
Tuck closure

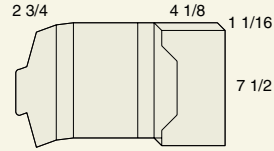

M-609 Video Mailer
with double wall left
panel and side load
compartment on right,
houses 1 VHS.
Wrap-around tuck
closure - Ships flat

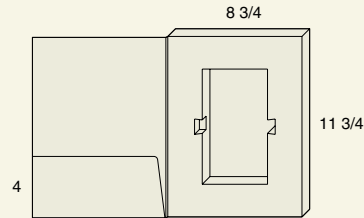

M-610 Video Cavity Box
with (1) 4" glued
horizontal left pocket.
Cavity on right with
tray houses 1 VHS.
Ships fully assembled.
Styrene reinforcement
optional.

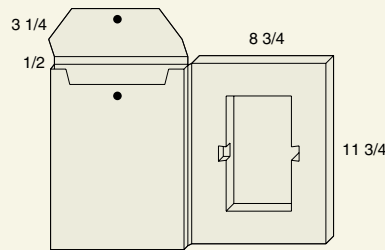

M-611 Video Cavity Box
with full 1/2" left
box pocket with flap
plus Velcro closure.
Cavity on right with
tray houses 1 VHS.
Ships fully assembled.
Styrene reinforcement
optional.

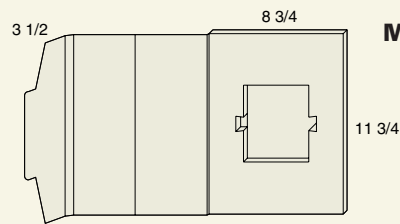

M-612 CD Mailer with (1) 4"
vertical left pocket with
stop tab. Cavity on right
with tray houses 1 CD
jewel case. Wrap-around
flap closure, ships fully
assembled. Styrene
reinforcement optional.

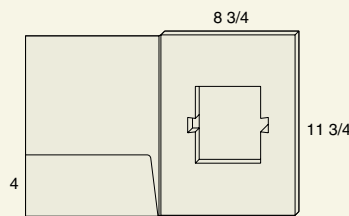

M-613 CD Cavity Box with (1)
4" glued horizontal left
pocket. Cavity on right
with tray houses 1 CD
jewel case. Ships fully
assembled. Styrene
reinforcement optional.

When it comes to CD and Video Packaging, no one does it better. We offer many styles to choose from. If you don't see one you like, give us a call, chances are we have it. Need something really special? Let us engineer it for you. We can design video cavity boxes with or without foam inserts. Our CAD department (computer aided design) can turn your ideas into reality.

M-600 through M-608 are produced on 12 Pt. C/1/S stock. Other stocks are available upon request. Consult our sales department for M-609 through M-613.

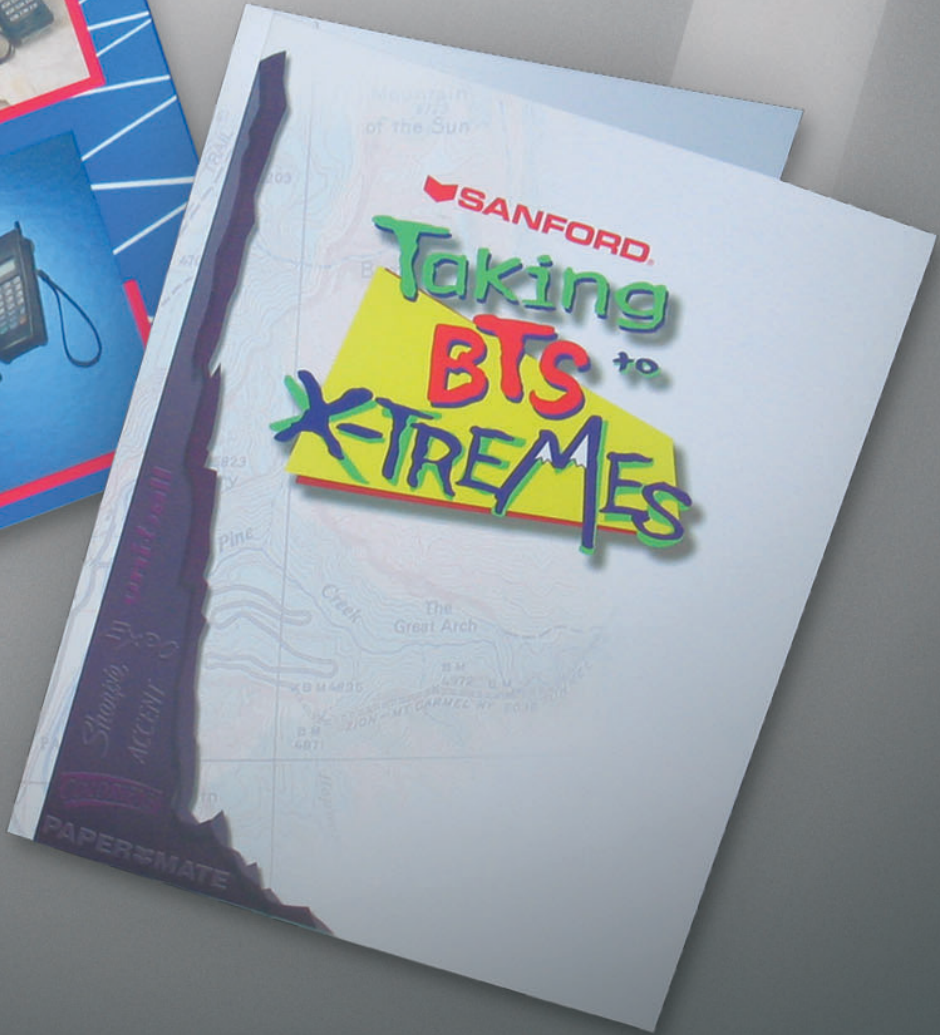

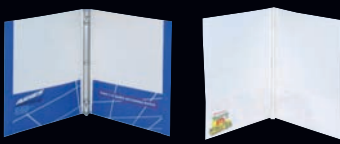

BINDERS • TANG PRODUCTS

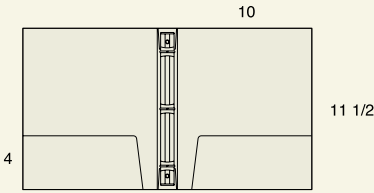

M-700 Binder with (2) 4" glued pockets (1/2" ring size shown)

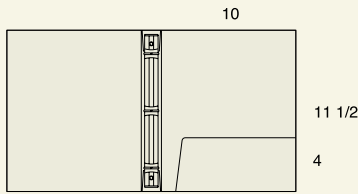

M-701 Binder with (1) 4" glued pocket (1/2" ring size shown)

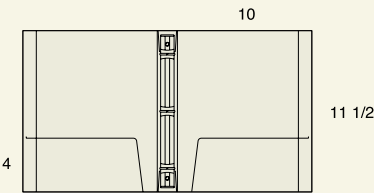

M-702 Binder with (2) 4" glued pockets and reinforced edges (1/2" ring size shown)

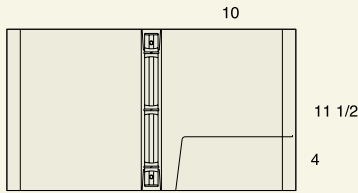

M-703 Binder with (1) 4" glued pocket and reinforced edges (1/2" ring size shown)

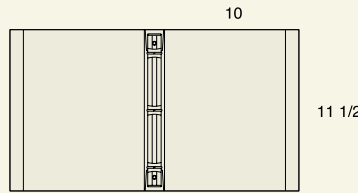

M-704 Binder without pockets (2) with reinforced edges (1/2" ring size shown)

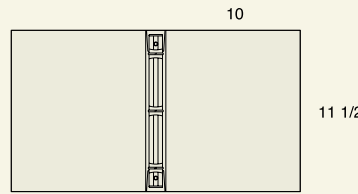

M-705 Binder without pockets (1/2" ring size shown)

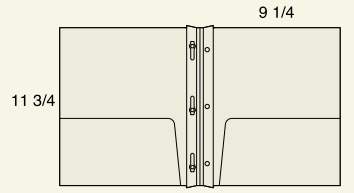

M-800 Tang Folder with (2) 5" glued pockets

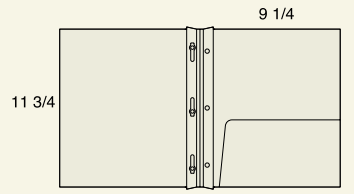

M-801 Tang Folder with (1) 5" glued pocket

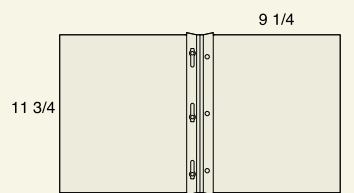

M-802 Tang Cover without pockets

Knife Back

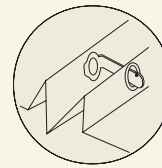

Box Back

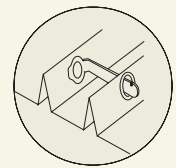

All binders are available with 1/2", 3/4" or 1" standard 3-hole ring metals or plastic "Tuffy" rings. Dies shown are our most popular styles. Many other styles are available or we can custom design one for you.

All Tang folders and covers are available with 3/4", 1 1/8", 1 1/2" or 2" fasteners.

Metal Ring

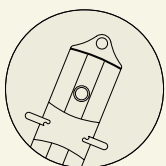

Tuffy Ring

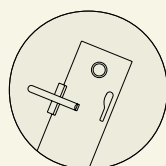

Binders are produced on 18 Pt. C/1/S stock and Tang Products are standard on 14 Pt. stock. Other stocks available upon request.

See page 6 for samples of our **Free** business card slits, CD and brochure slits and windows.

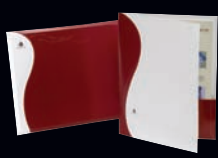

CONFORMER® EXPANSION PRODUCTS

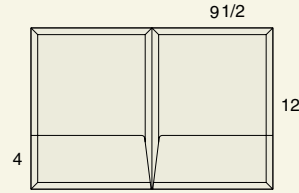
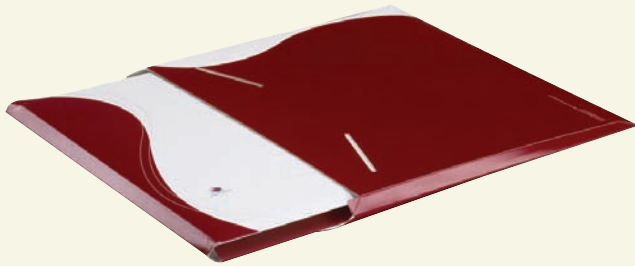

M-900 9 1/2 x 12
Conformer® Expansion
Folder with (2) 4"
glued pockets

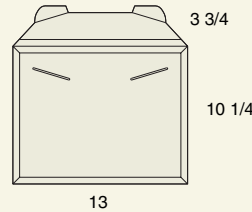

M-901 13 x 10 1/4
Conformer® Expansion
Portfolio/Mailer
with 3 3/4" flap
and Tuck closure

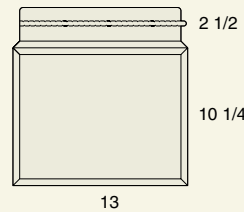

M-902 13 x 10 1/4
Conformer® Expansion
Portfolio/Mailer
with 2 1/2" flap
and zip strip



Expansion That Fits

Conformer® Expansion Folders and Portfolio/Mailers expand to fit and protect their contents. With their unique patented designs, they can hold from 1 to 100 sheets of paper, spiral bound books and other materials of varying thicknesses.

Branding That Sells

Use a folder by itself or pair it up with a matching portfolio / mailer for a greater impact. Promote your corporate identity by placing a courier's shipping label directly onto your branded portfolio / mailer.

Conformer® Expansion Products stay flat when filled and pack flat for economical shipping and storage. We can also produce Conformer® Expansion Products in custom sizes and stocks to fit your needs.

We are a licensed manufacturer of Conformer® Expansion Products. Patent numbers must appear on all Conformer® Expansion Products and will be added in small type to one of the panels.

Conformer products are produced on 12 Pt. C/1/S stock, 14 Pt. is recommended for heavy applications. Other stocks are available upon request.

See page 6 for optional center "Tang" attachments that are available for Conformer® folders. Also listed on page 6 are samples of our **Free** business card slits, CD and brochure slits and windows.

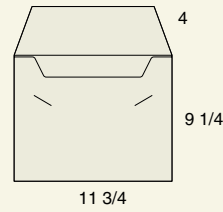

M-1000 Flat portfolio
11 3/4 x 9 1/4
with 4" flap.
12 Pt. C/1/S

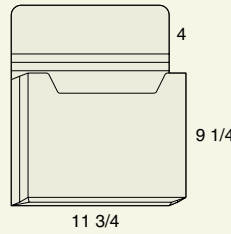

M-1001 Expandable portfolio
11 3/4 x 9 1/4
with 4" flap.
Available in 1 1/4",
1 1/2", or 2" capacity.
12 Pt. or 14 Pt. C/1/S

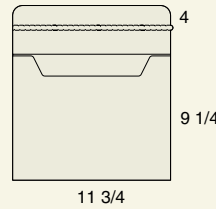

M-1002 Flat portfolio
with zip strip
11 3/4 x 9 1/4
with 4" flap.
12 Pt. C/1/S

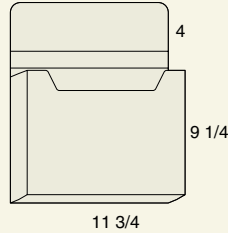

M-1003 Fixed capacity tote
11 3/4 x 9 1/4
with 4" flap.

Totes are available in 5/8", 1", 1 1/2" or 2" capacity and come standard with 1 set of Velcro dots. Totes ship fully assembled. 18 Pt. C/1/S

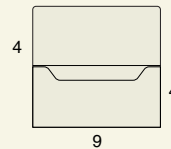

M-1004 Wallet
9 x 4
with 4" flap.
12 Pt. C/1/S

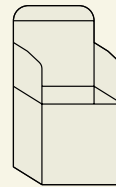

M-1005 Double tuck box.
Call for stock and
custom sizes.

These are just a few of our dies available. Give us a call and we will find the right product for you or engineer one to specifically fit your needs.



CUSTOM PACKAGING



We design and manufacture a broad range of products that can bring a unique and lasting impact to your communication programs. Our complete line of custom packaging can add excitement, organization and performance to your graphic ideas. Our ability to custom design products to meet your most specified needs provides you with an unlimited variety of creative solutions.

Our design and product development group will work with you every step of the way, helping you select the products that best meet your creative and budget objectives. Because we utilize a CAD system (computer aided design) in all of our design work, we can provide prototypes made to your specifications, enabling you to plan each project with greater precision.



As a leading innovator in the art of packaging communications, We are committed to uncompromising excellence in every product we make. With all of our manufacturing resources in house, we maintain the highest standards of quality control, delivering every product with single-source reliability and convenience.

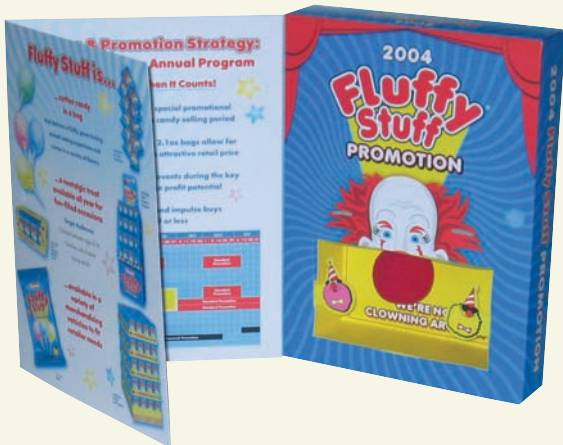

COMMERCIAL PRINTING



What a category! From annual reports to product literature, from inserts to self-mailers, We can produce it all. You can rely upon us for stand-alone jobs or for companion pieces to packaging projects.

Our main focus has always been quality, value and commitment to our clients. As our client, you depend on your business partners to be educated, experienced, innovative and dependable. We know that. That's why everyday we put as much energy and creativity into the production as the designer put into the concept and artwork.

Our team is prepared to lay it on the line for our clients. We have a passion for our craft and continually surpass expectations.





FOIL STAMPING • EMBOSSING • DIE CUTTING..



Foil Stamping, Embossing, Die Cutting... A lost art? Not at all! We combine the craftsmanship and knowledge of our artisans with the today's technology to produce some of the most stunning foil and embossing effects. Need help or suggestions on ways to dress up your next project? We're here for you.



Weather you are looking for a foil accent, foil embossing, sculptured die effects or any other special effect, We are your source. Give us a call for suggestions or free samples.



Don't stop with foil stamping and embossing. We can help you with all of your die cutting requirements. From simple die cuts to the most intricate designs, we can do it all. And, we can provide you with exact prototypes and electronic die lines for your graphic designer. Need to alter a die line or prototype? Not a problem. All die lines and prototypes are produced on a CAD system (computer aided design) making changes easy. Since all design is done electronically, all files are archived for future use.



PRICING	It is important to note that all printing prices in this price book are based on artwork being furnished by the client on disk. (See "Artwork" for more details.) Prices are based on Northern Printing receiving "Out Ready" files. Our prices include <u>ALL</u> prep work, including, ripping, trapping, and imposition. Our prices also include your first proof. If additional proofs are required due to alterations, you will be charged accordingly. If you choose to furnish film, please call for a quote.
ARTWORK, DISKS, ELECTRONIC ARTWORK	Our pre-press department operates on an electronic workflow. We prefer to receive your artwork electronically. You can provide this to us on disk, by e-mail for small files or by sending larger files to our FTP site. Please contact our prepress department prior to sending files to our FTP site. We can provide electronic die lines for you to place your artwork into. These can be downloaded at www.northernprint.com or we can e-mail them to you. We accept MAC and MAC compatible files. Acceptable programs are QuarkXpress, Page Maker, Illustrator and PhotoShop. Please contact us prior to sending files in any other program. Additional charges may apply. All files must have a laser output. You can fax a copy if you send files by e-mail or FTP. Customer files are reviewed and pre-flighted before output. Do not trap files - ripping, trapping and imposition are included in the price. We will provide these services to our standards; however, additional work necessary to correct your files, including typesetting, will incur additional charges. Northern Printing cannot be held liable for errors in customer furnished files. We require a signed proof to be returned to us for production to begin. All production times begin from the time we receive the proof back with an OK to print. All files, plates, brass dies and job materials are stored for 3 years. If we have not received a request for materials to be returned or a report order in that time, the materials will be discarded.
CHANGES AND CANCELLATIONS	Changes to an order already in progress may incur additional charges. These costs are determined per job. Cancellation for work in progress will require payment for work performed, materials ordered and any re-stocking charge incurred.
DAMAGED GOODS	Claims for materials damaged in transit must be made with the carrier and are the responsibility of the consignee. Contact us immediately so we can provide you with the necessary information. All claims must be made within 30 days.
EMBOSSING	Embossing requires a special die. The cost for die is additional and is based on a single level die. Domed, sculptured or special effect dies will incur additional costs. Copy will be raised to the maximum lift allowed by the stock and copy design. Copy must remain 1/8" away from scores and folds. Screens and type smaller than 8 point is not recommended
ERRORS	In the event of an error on our part, our liability is limited to the value of the product manufactured. If replacements is warranted, we will produce the product according to original specifications without alterations. If you choose to make changes at that point, you will incur additional costs and are subject to Northern's approval.
FILM SUBMISSION	Film should be right reading (emulsion down, 150 or 200 line screen) ready to plate. Be certain .004 traps have been applied. All PMS colors must be provided along with a match print proof.
FOIL STAMPING	Foil stamping, like embossing requires a special die. The cost for a die is additional. Copy must remain 1/8" away from scores and folds. Screens and type smaller than 8 point is not recommended. Refer to our foil chart for stock colors. Custom colors are available for an additional cost.
LAMINATION	Film lamination is available for most products at an additional cost. Lamination adds protection and durability.
OVERRUNS OR UNDER-RUNS	Each order we receive is custom made. Due to the number of production processes used to manufacture your order, it is not possible to determine the exact quantity we will complete. Unless otherwise indicated on your purchase order, your order will be produced in accordance with the "Standard Trade Practice". See definitions below if you request "No Overs" or "Exact Quantity". Standard Trade Practice - You will be billed for the exact quantity shipped not to exceed 10% over or under the quantity you have ordered. No overs - If you request No overs, it is possible your order could run short by more than 10%. Exact Quantity, No Less Than or No Unders - Add 10% to the price of your order for special handling involved.
PAYMENT TERMS	With pre-approved credit, payment must be received 30 days from invoice date. First time orders require 50% deposit. We accept checks and Visa.
PRODUCTION TERMS	Production times vary depending on the product. Consult with our sales representatives for your special needs.
PROOFS	Your first proof is included in the price. Proofs must be returned with a signed proof tag for production to begin. Any changes to the proof will incur additional charges.
RIGHTS TO PROMOTION	We reserve the right to use in our advertising any items we produce unless you notify us in writing at the time the order is placed.
RUSH ORDERS	Every effort will be made to deliver your job when you need it under normal production times. Occasionally, you may need your product faster and you will incur rush charges. These are evaluated on a per job basis and must be approved in writing prior to us proceeding.
SAMPLES	We have a large sample department. Call, write or e-mail us for the type of samples you need. Samples are free of charge and are shipped UPS ground or regular mail.
SHIPPING	Orders are normally shipped F.O.B. our Illinois factory. Unless specified, we will select the carrier. Inside deliveries must be indicated with your order. Delivery dates refer to the day your product will leave our factory. We cannot be responsible for arrival date. We can split ship your order. Split shipment charges are \$10.00 per location after the first location. We will bill your order complete at the time of your first shipment.



1400 South Wolf Road
Wheeling, IL 60090
847.215.7300
www.npn360.com